

HM Schooner Pickle
Scale 1:64
Sheet 4 of 6
Rigging Stage 1 & 2

Heritage Series
Model Code
9018

©2006 JoTiKa Ltd.

Manufactured & Distributed in the U.K. by JoTiKa Ltd., Model Marine Warehouse, Hadzor, Droitwich, Worcestershire, WR9 7DS.
 Telephone: 01905 776 073 Fax: 01905 776 712 E-Mail: heritage@jotika-ltd.com
 Web Address: http://www.jotika-ltd.com

U.S. Distributor: Aeromarine Laminates Inc., 22762 Sussex Hwy, Seaford Delaware, DE 19973.
 Telephone: 302 628 3944 Fax: 302 628 3945 E-Mail: aeromarine@erols.com
 Web Address: http://www.aeromarine.com

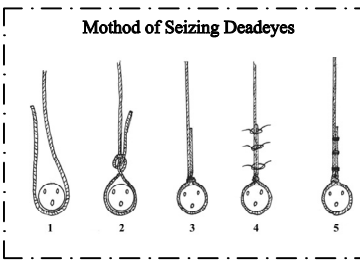
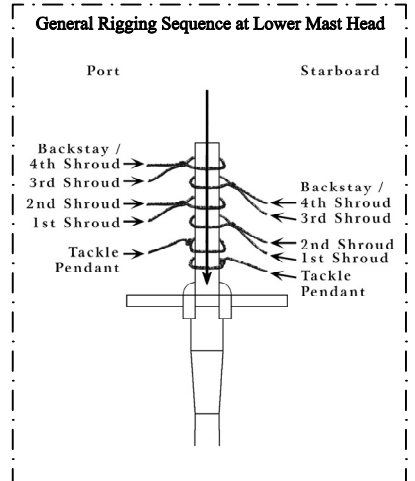
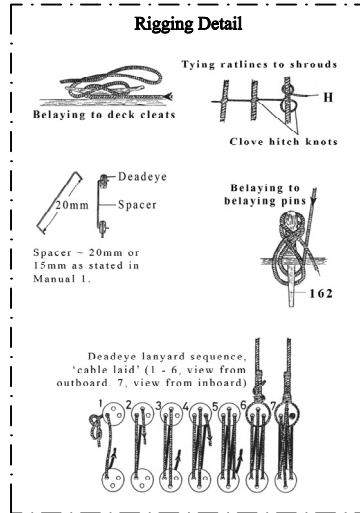
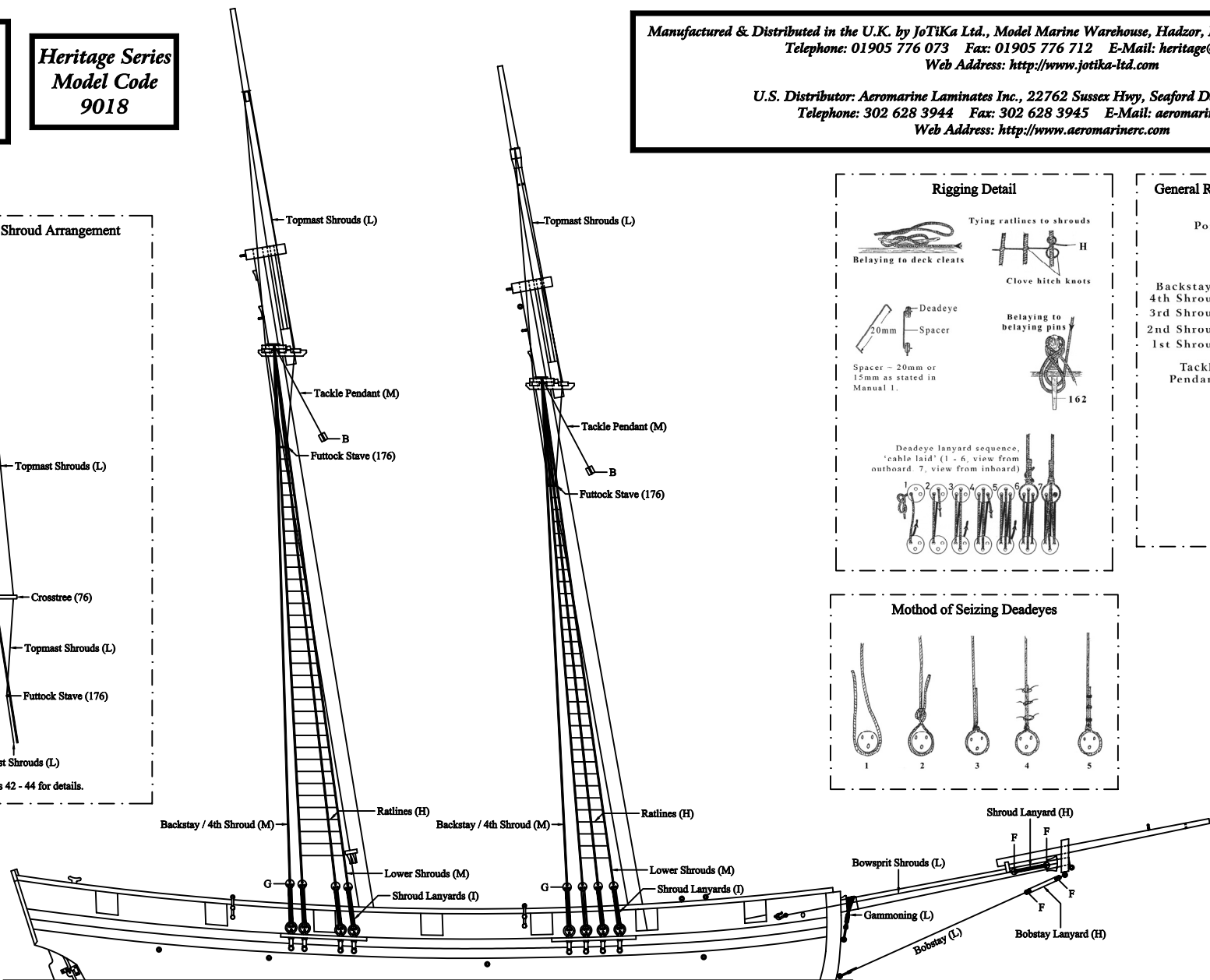
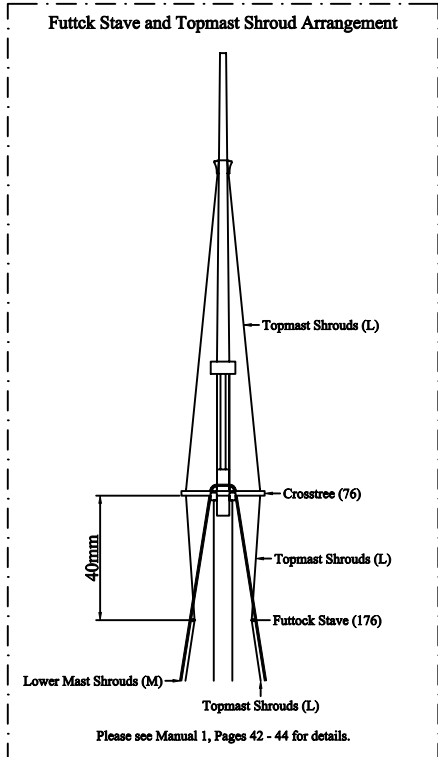

- Key to Threads & Blocks**
- A ~ 2.5mm Single Block
 - B ~ 3mm Single Block
 - C ~ 3mm Double Block
 - D ~ 5mm Single Block
 - E ~ 5mm Double Block
 - F ~ 2.5mm Deadeye
 - G ~ 3.5mm Deadeye
 - H ~ 0.1mm Natural Thread
 - I ~ 0.25mm Natural Thread
 - J ~ 0.25mm Black Thread
 - K ~ 0.50mm Natural Thread
 - L ~ 0.50mm Black Thread
 - M ~ 0.75mm Black Thread
 - N ~ 1.00mm Black Thread
 - O ~ 1.3mm Natural Thread

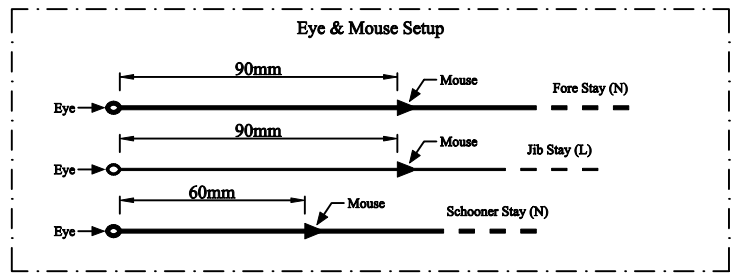
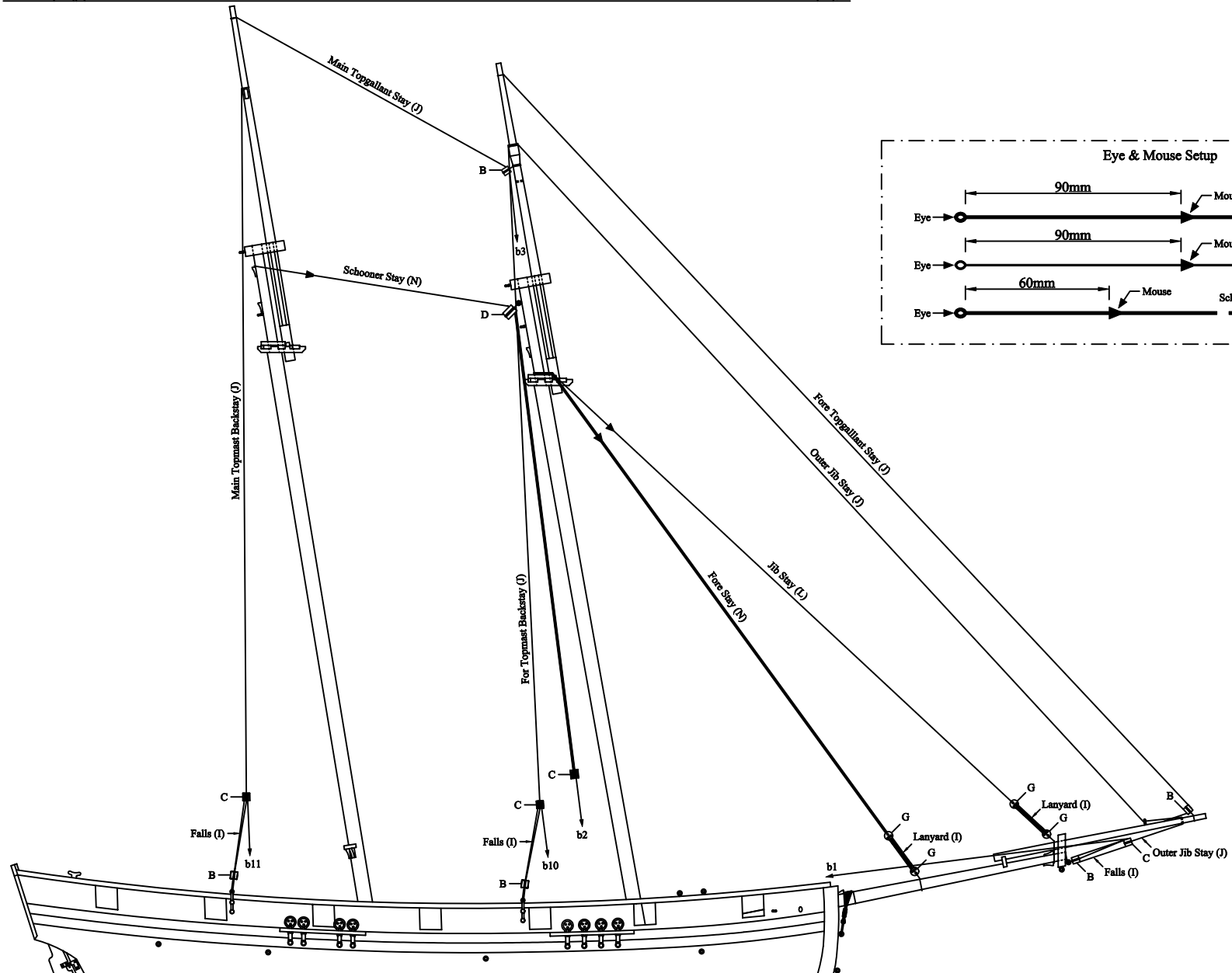

- Key to Threads & Blocks**
- A ~ 2.5mm Single Block
 - B ~ 3mm Single Block
 - C ~ 3mm Double Block
 - D ~ 5mm Single Block
 - E ~ 5mm Double Block
 - F ~ 2.5mm Deadeye
 - G ~ 3.5mm Deadeye
 - H ~ 0.1mm Natural Thread
 - I ~ 0.25mm Natural Thread
 - J ~ 0.25mm Black Thread
 - K ~ 0.50mm Natural Thread
 - L ~ 0.50mm Black Thread
 - M ~ 0.75mm Black Thread
 - N ~ 1.00mm Black Thread
 - O ~ 1.3mm Natural Thread