

1/1000th R.M.S TITANIC 타이타닉

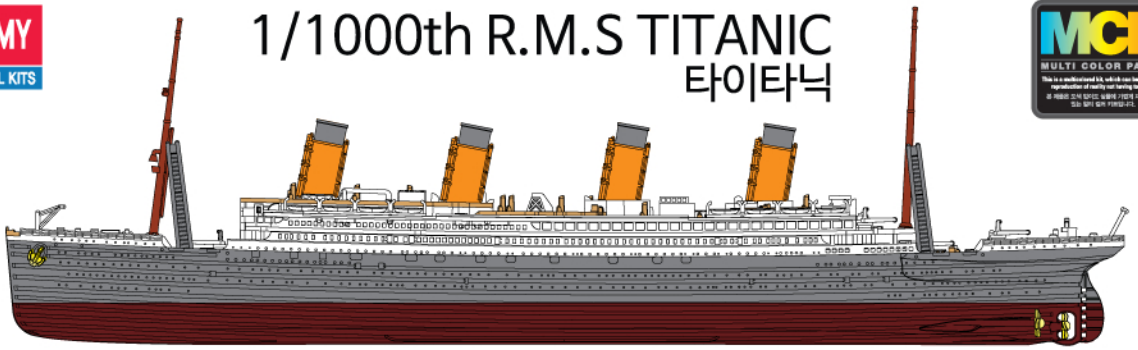

14217



Warning before assembly of model kits
조립전의 주의사항

Take care not to injure yourself while using the modeling tools to cut or trim parts.
공구를 이용하여 부품을 다듬고 자를 경우, 손을 다치지 않도록 주의를 기울여 주십시오.

★ **This is a multicolored kit, which can be a precise reproduction of reality not having to paint.**
본 제품은 도색 없이도 실물에 가깝게 재현할 수 있는 멀티 컬러 키트입니다.

▶ parts location diagram / 부품도

A

B

C

D

E

F

G

● Front rail part
앞쪽난간 부품

● Rear rail part
뒤쪽난간 부품

● Deck part
갑판부품

● Hull part 1
선체부품 1

● Hull part 2
선체부품 2

1

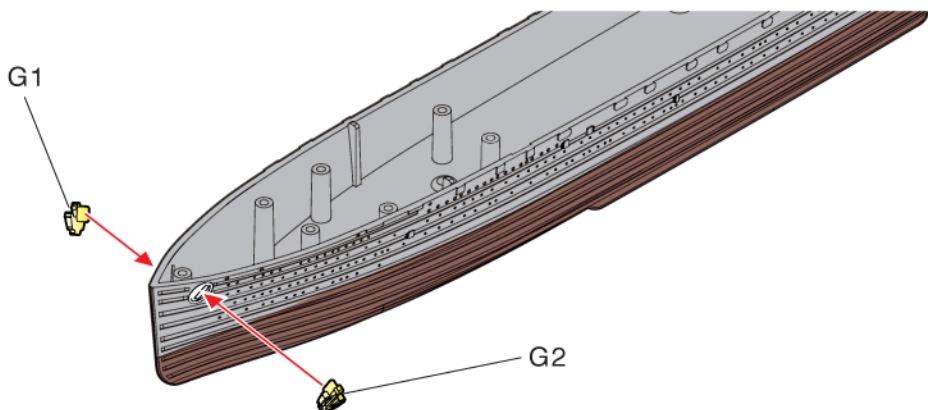
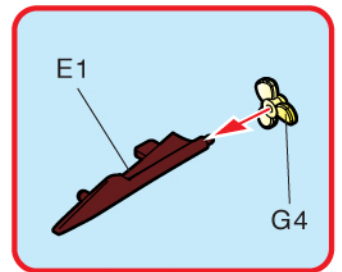
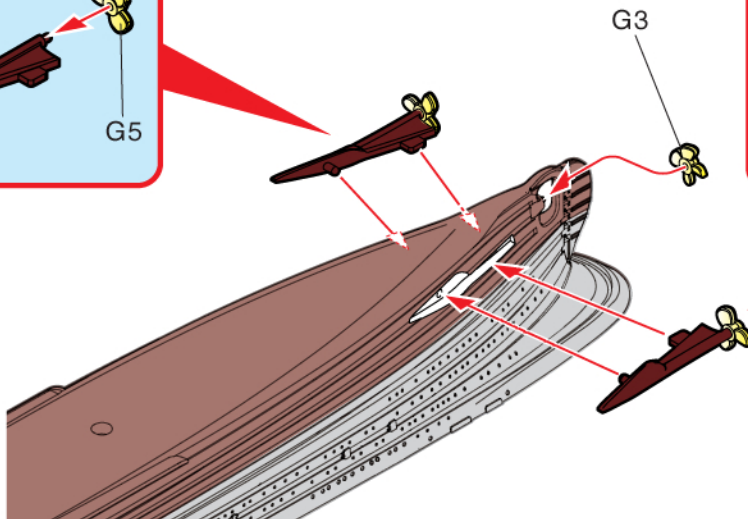
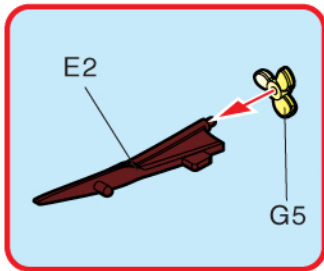
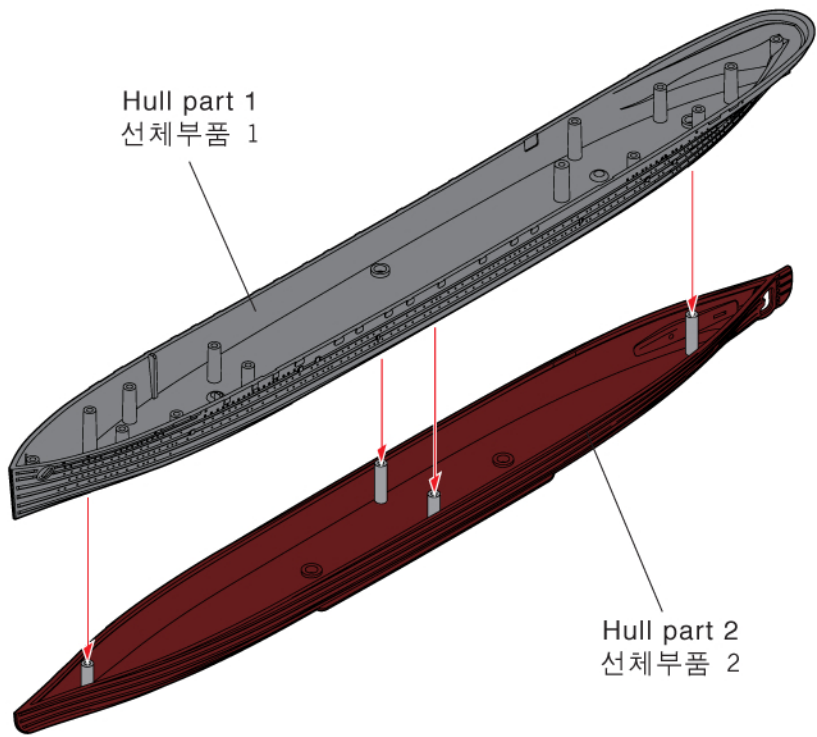

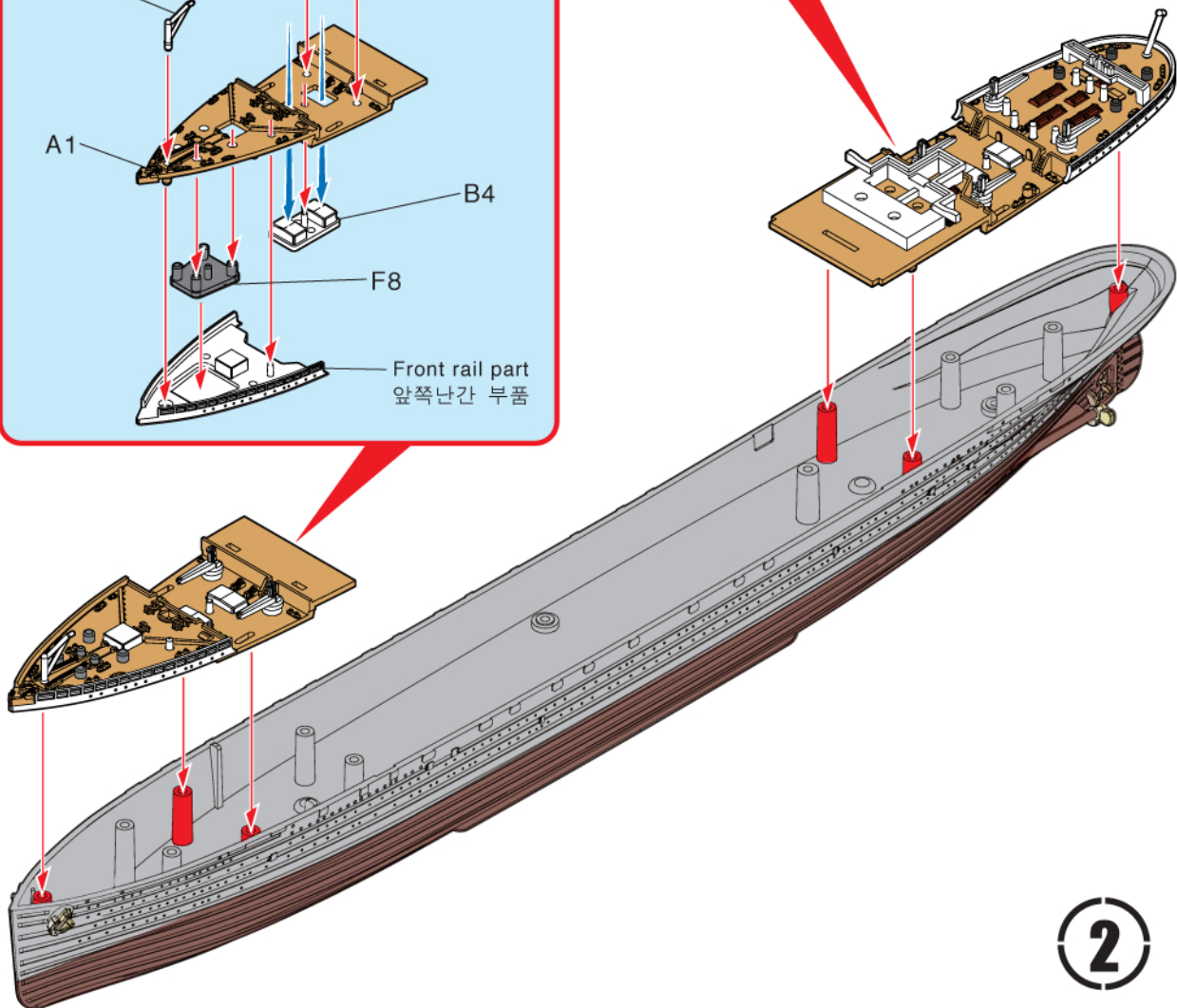
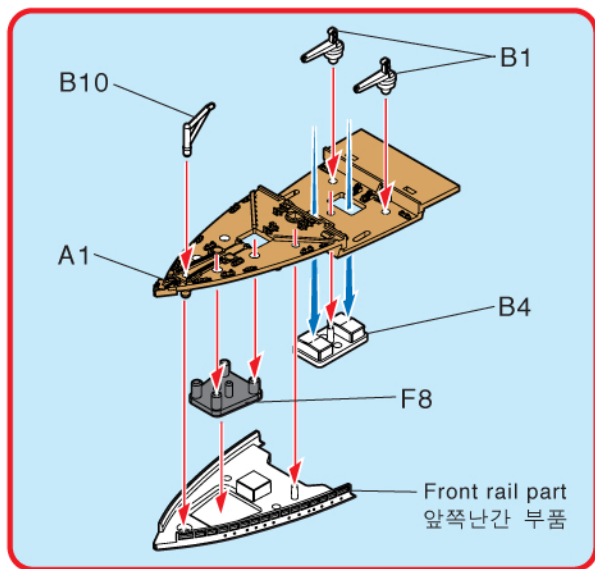
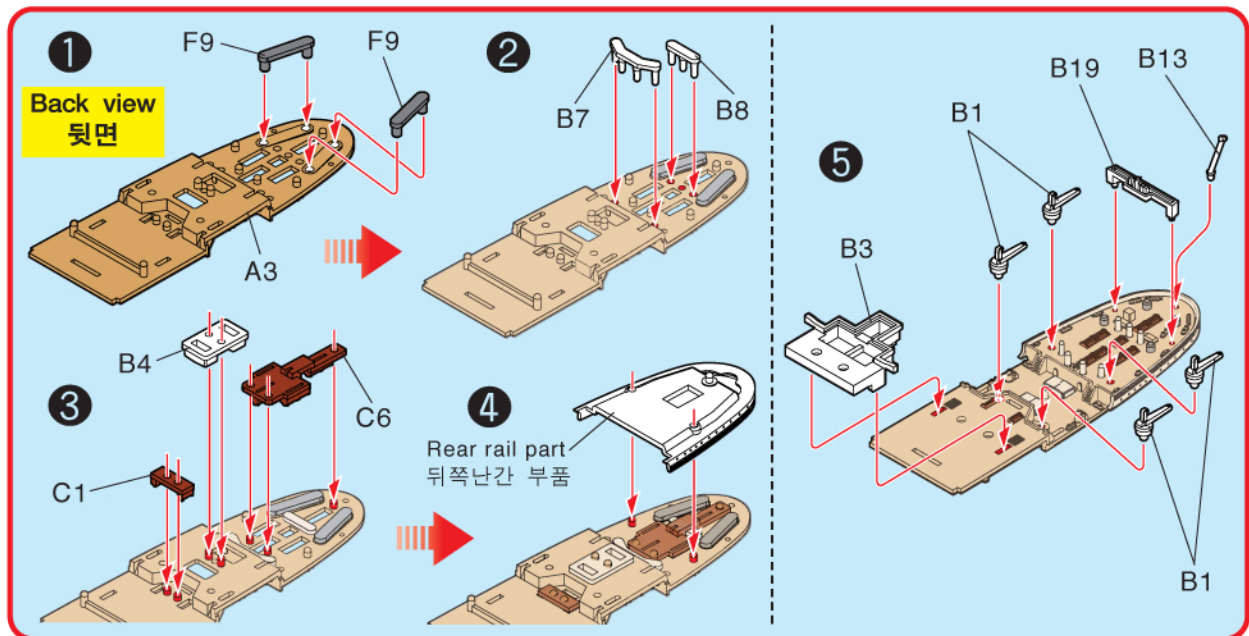

4

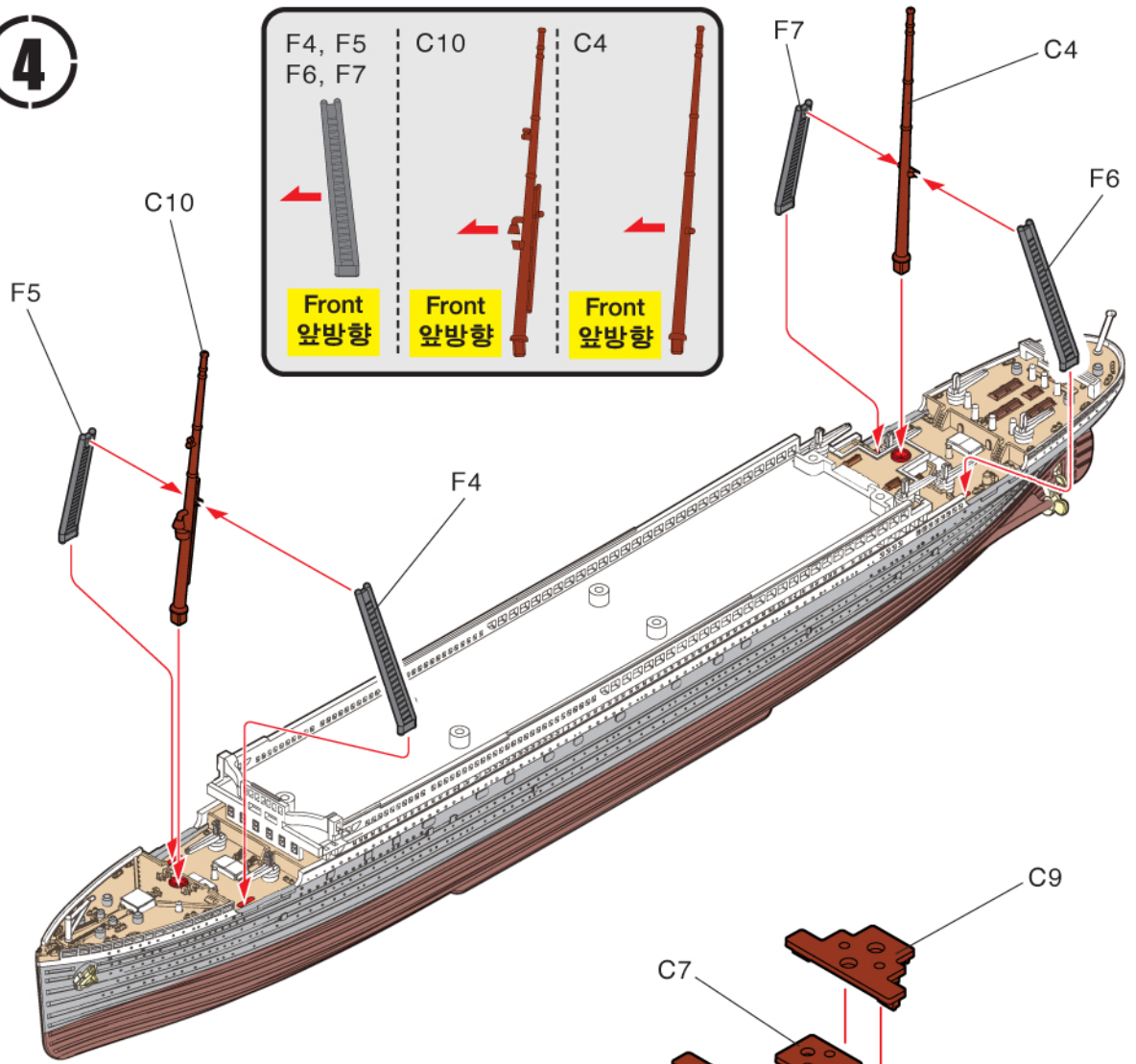
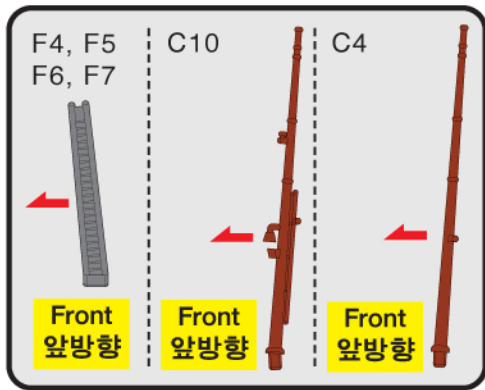

5

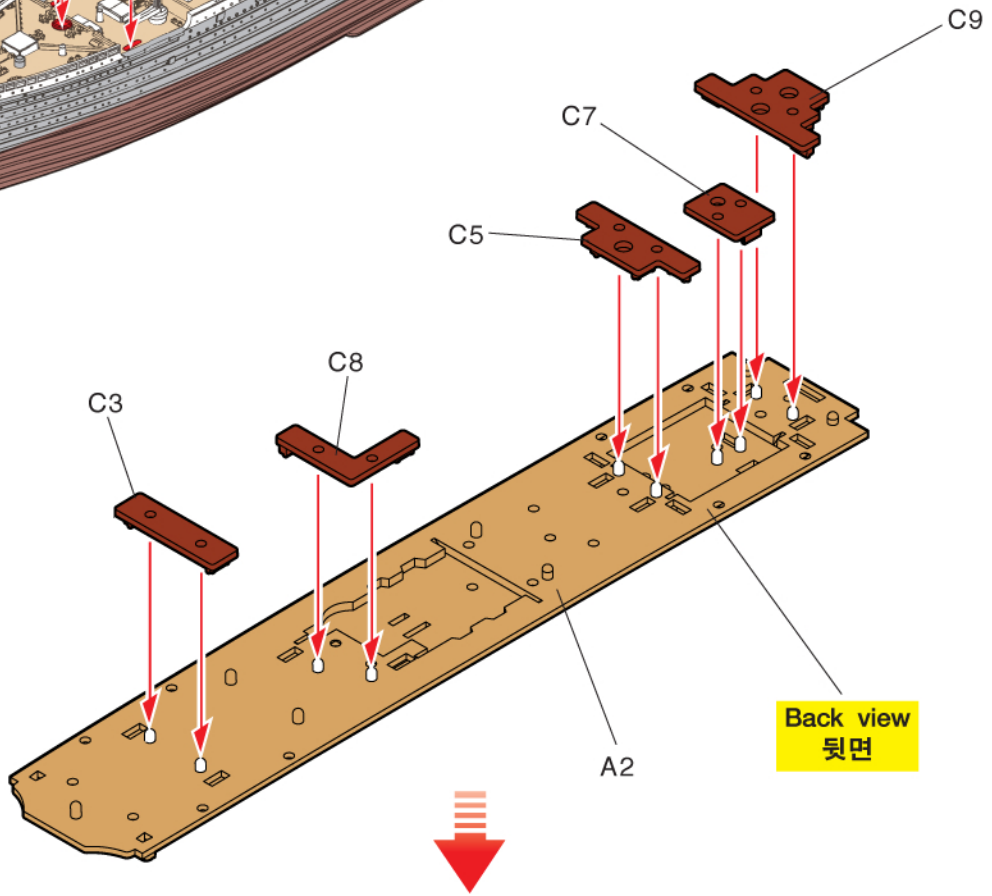

6

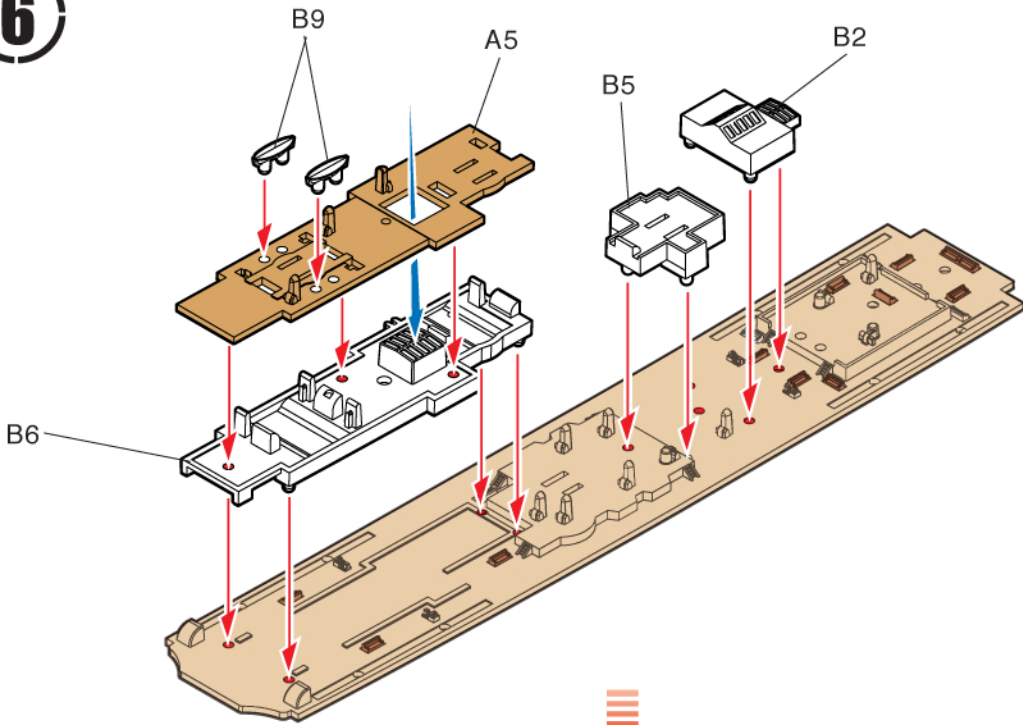

7

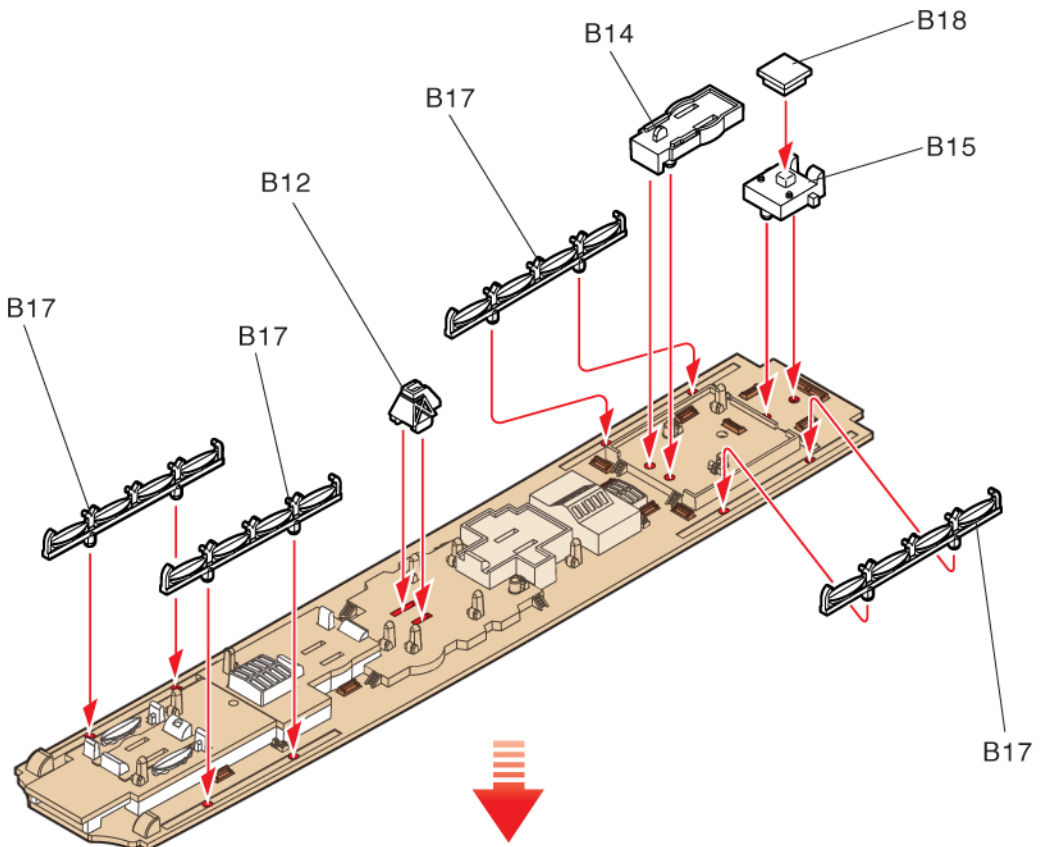

8

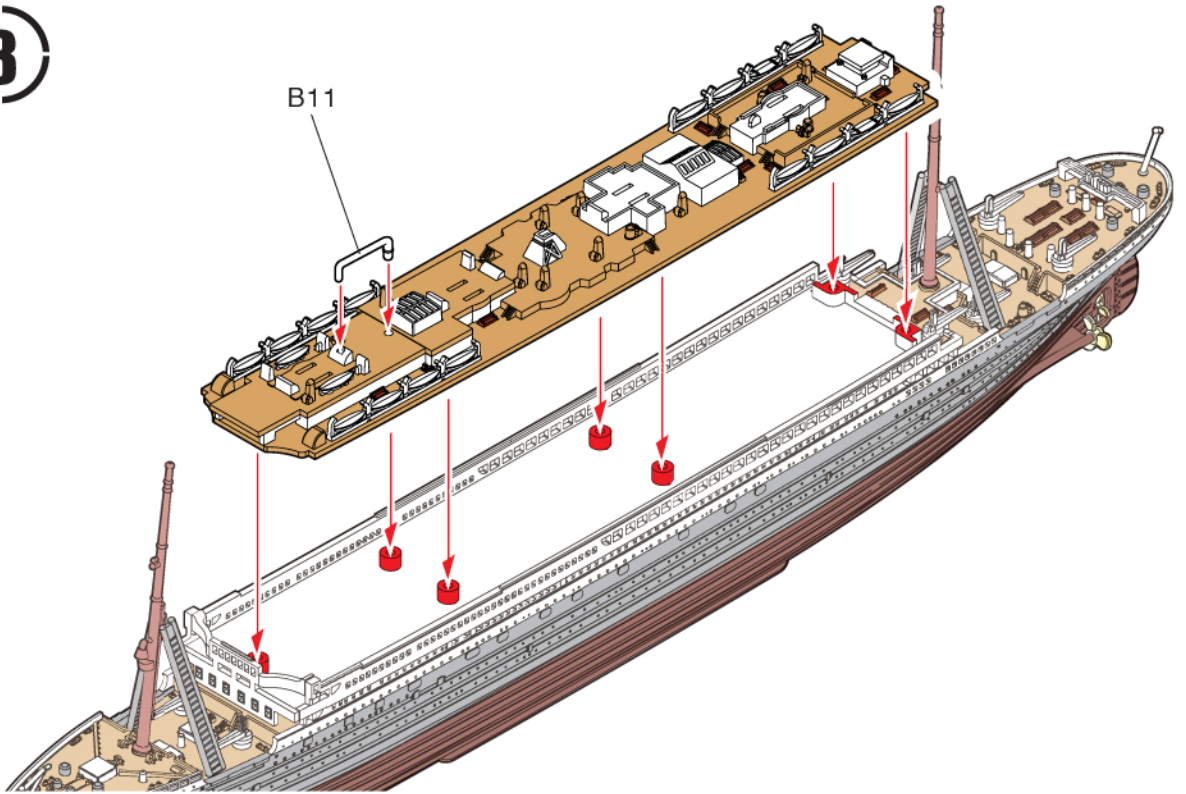

9

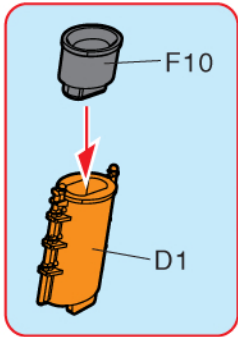

4EA
4개조립

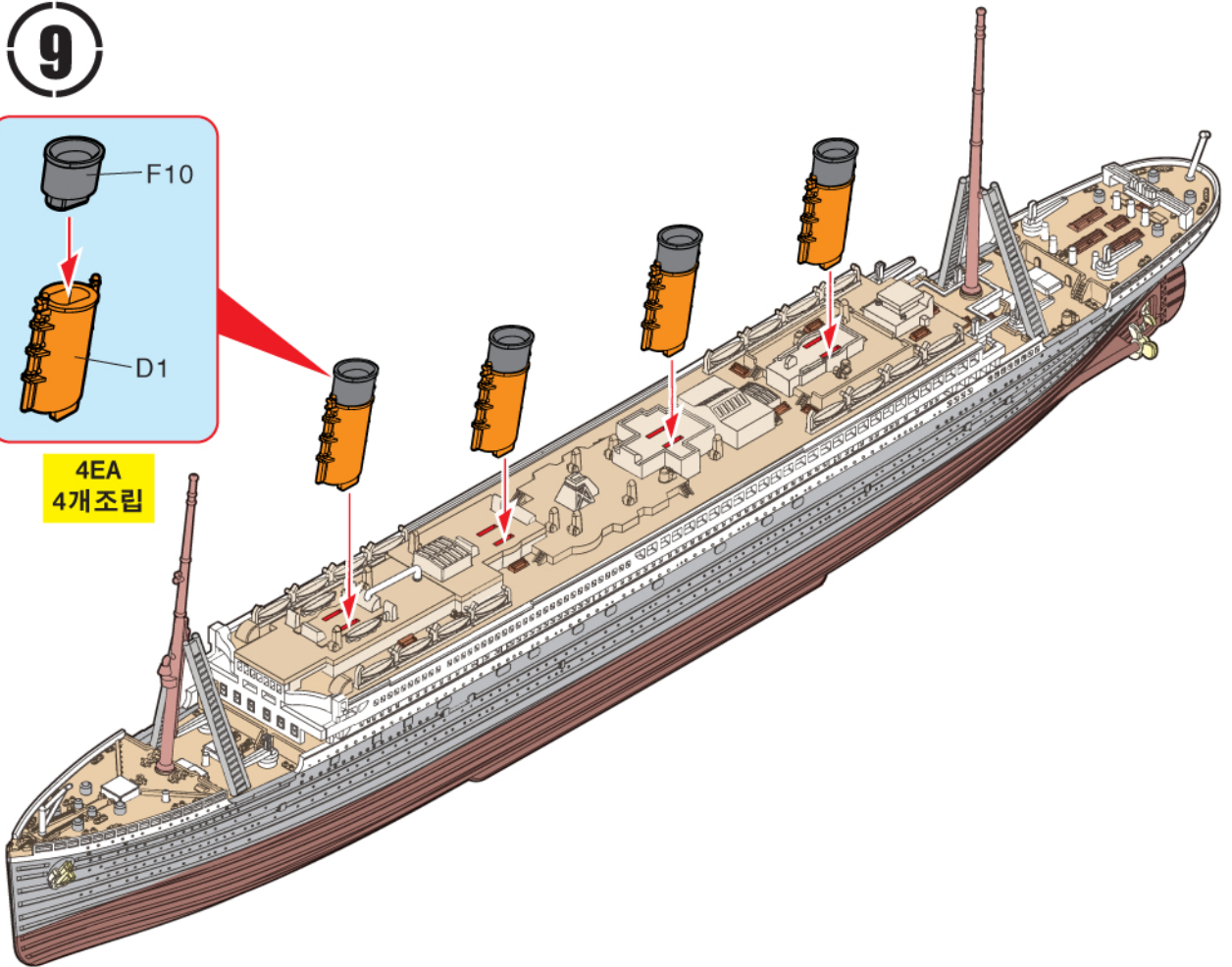

10

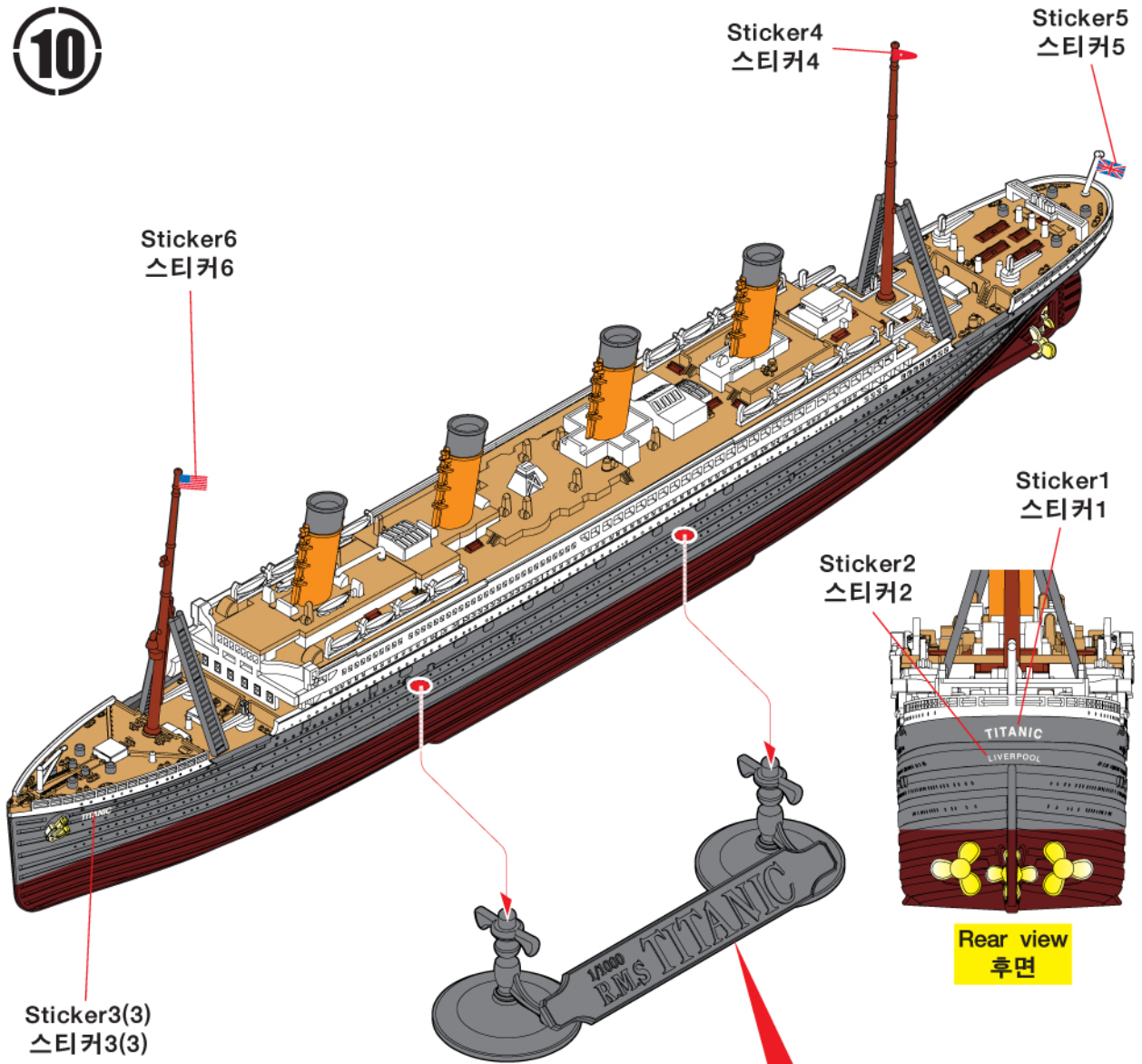

※ () is opposite number.
()는 반대측 번호입니다.

